

MEMS Fiber Optical Variable Attenuator Ø 2.5 mm 2D

(850nm, 1260-1630nm, 500mW)



DATASHEET

[Return to the Webpage](#)



Features

- High Repeatability
- Low Power
- Small

The VOAM Series of MEMS Fiber Optical Variable Attenuator is constructed using an electrostatic rotating mirror hermetically sealed with nitrogen, featuring high repeatability, low power consumption, and low cost. A voltage between 0-6V on the drive pin sets the optical attenuation. When power is removed, the VOA returns to its default state. The device's electrical character is capacitive without polarity. It can be mounted directly on printed circuit boards. The VOAMs are bidirectional. The component is compliant with RoHS requirements and Telcordia standards GR1221 qualified.

Agiltron provides customized designs and modular assemblies to meet control and integration applications.

Specifications

Parameter		Min	Typical	Max	Unit
Operation Wavelength	Single Mode	780		2200	nm
	Multimode	810-890	1260-1360	1500-1600	
Insertion Loss ^{[1], [2]}			0.5	1.0	dB
PDL (SM)				0.3	dB
Repeatability (0-30, @15dB)			0.1	0.2	dB
Wavelength Dependent Loss (@20dB)				0.63	dB
Extinction Ratio (PM fiber)		18		30 ^[3]	dB
Repeatability (@10dB, 0-60 °C)	Uncompensated		0.3	0.5	dB
	Compensated		0.1	0.2	
Return Loss	SM, PM	50			dB
	MM	35			
Attenuation	SM, PM	40			dB
	MM	30			
Driving Voltage	SM, PM	0	6	10	V
	MM	0	9	10	
Response Time			0.5		ms
Repetition Rate			50	100	Hz
Durability			10 ¹²		Cycle
Power Consumption				20	µW
Power Consumption (at maximum)				0.2	mW
ESD				500	V
Operating Temperature ^[4]		-10		70	°C
Storage Temperature		-40		85	°C
Optical Power Handling			300	500	mW

Notes:

[1]. Excluding connectors. Each connector adds 0.3dB @1550nm. Wavelength shorter and longer will increase loss.

[2]. Multimode IL measured @ Light Source CPR < 14dB

[3]. 30dB PER is available with special order

[4]. Lower temperature version is available, please call us

Legal notices: All product information is believed to be accurate and is subject to change without notice. Information contained herein shall legally bind Agiltron only if it is specifically incorporated into the terms and conditions of a sales agreement. Some specific combinations of options may not be available. The user assumes all risks and liability whatsoever in connection with the use of a product or its application.

Rev 10/24/24

MEMS Fiber Optical Variable Attenuator \varnothing 2.5 mm 2D

(850nm, 1260-1630nm, 500mW)



DATASHEET

Mechanical Dimensions (mm)

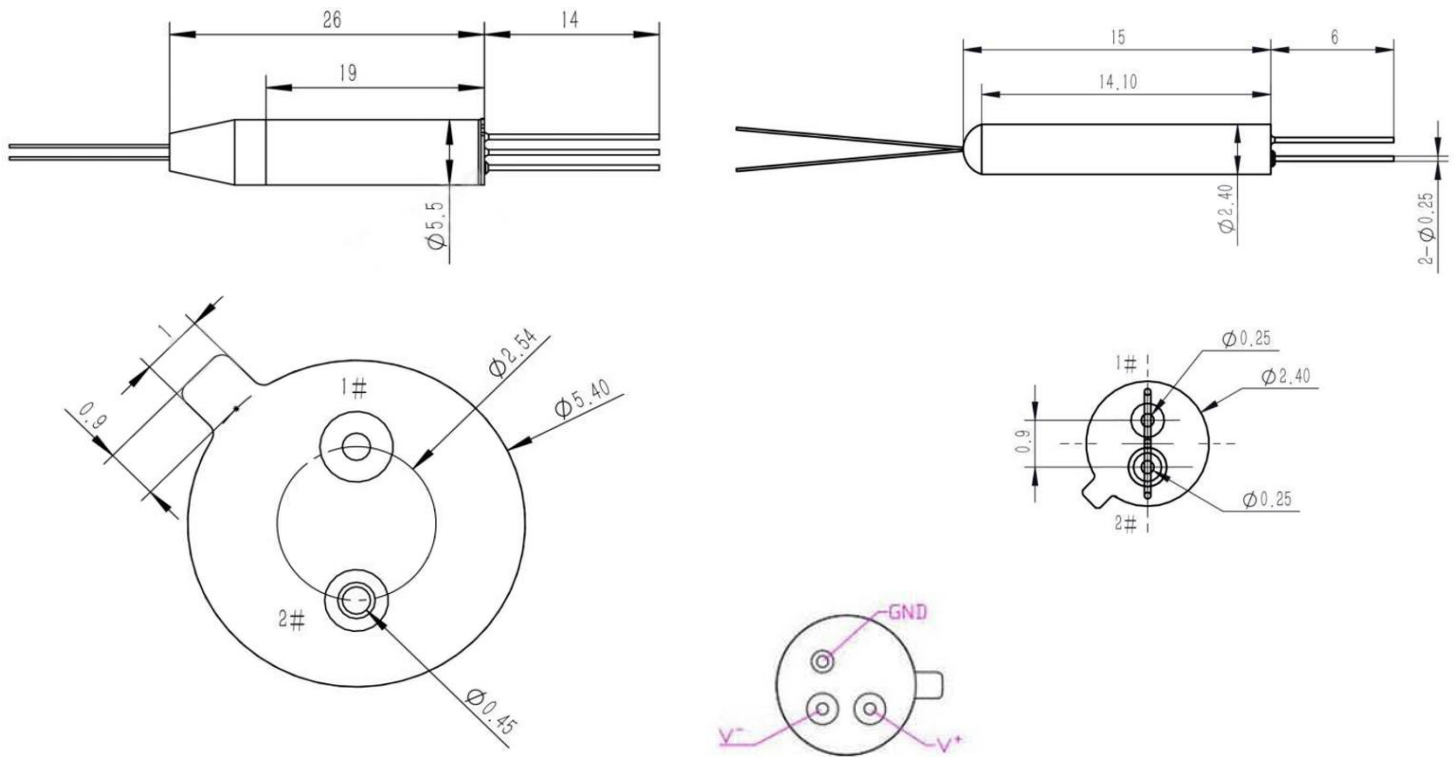

*Product dimensions may change without notice. This is sometimes required for non-standard specifications.

Electrical Driving Requirements

- 1) Capacitive load device, no polarity. Applying a voltage between Pin1 and Pin2
- 2) The maximum rating voltage is 12V
- 3) The ground pin is optional and can be cut off

MEMS Fiber Optical Variable Attenuator \varnothing 2.5 mm 2D

(850nm, 1260-1630nm, 500mW)



DATASHEET

Typical Attenuation vs. Voltage at 25°C, 55°C, 70°C

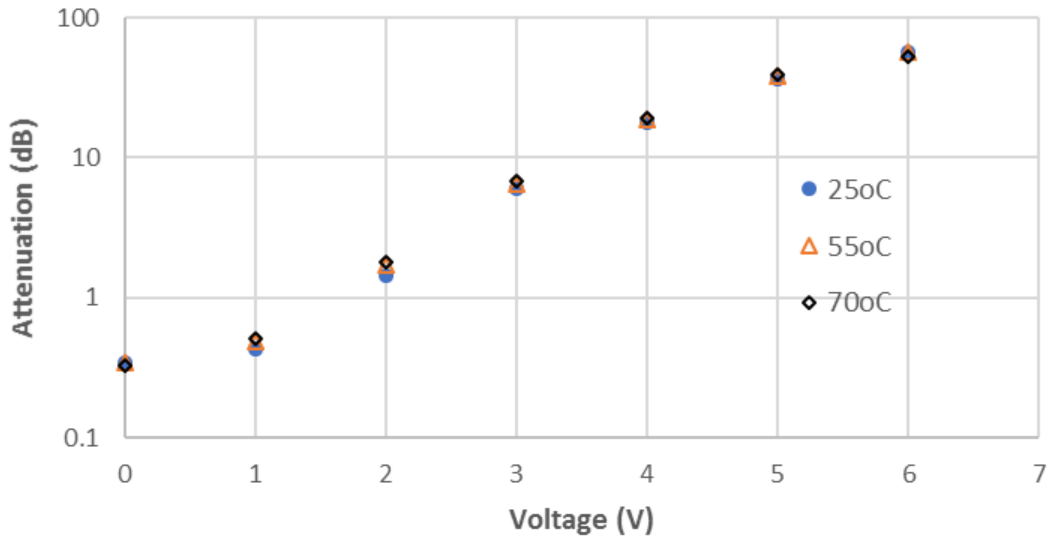

Typical Insertion Loss vs Wavelength (1240-1630nm)

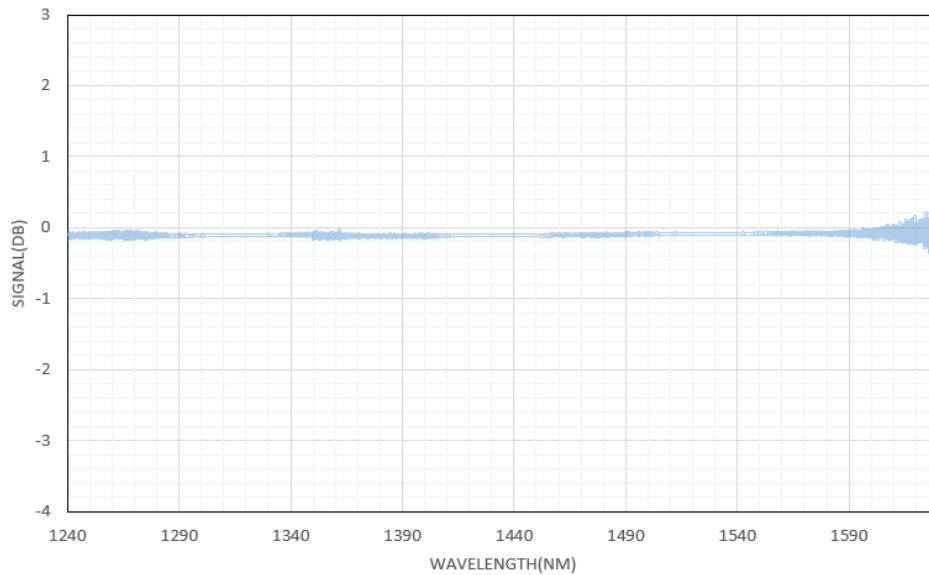

MEMS Fiber Optical Variable Attenuator Ø 2.5 mm 2D

(850nm, 1260-1630nm, 500mW)



DATASHEET

Wavelength Dependence 10 dB

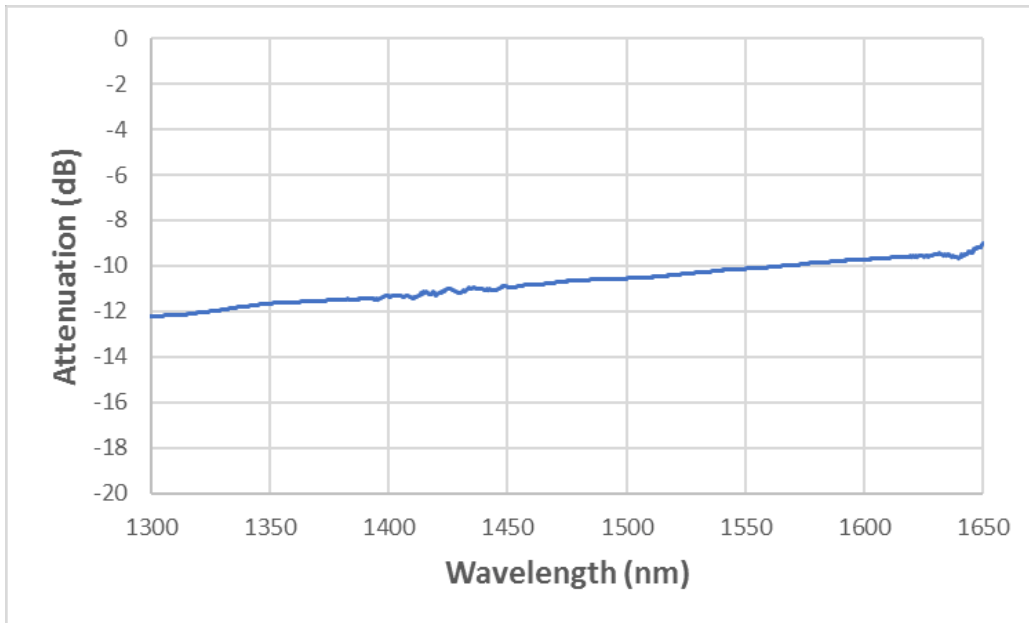

Wavelength Dependence 0.5 dB

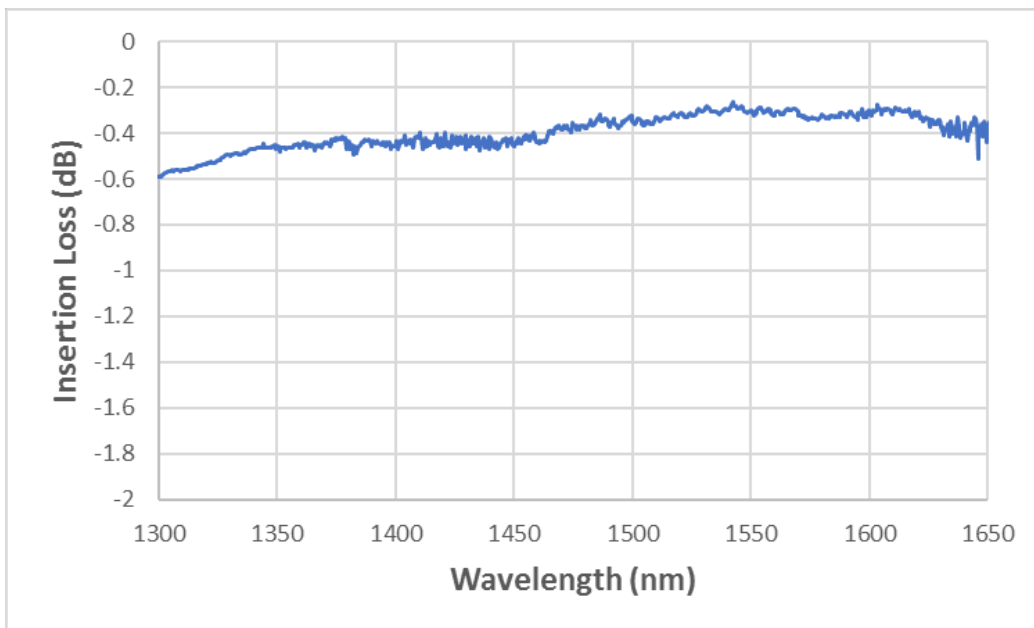

MEMS Fiber Optical Variable Attenuator Ø 2.5 mm 2D

(850nm, 1260-1630nm, 500mW)



DATASHEET

Typical Repeatability -Attenuation vs Applying Voltage Over 5days (5 colors)

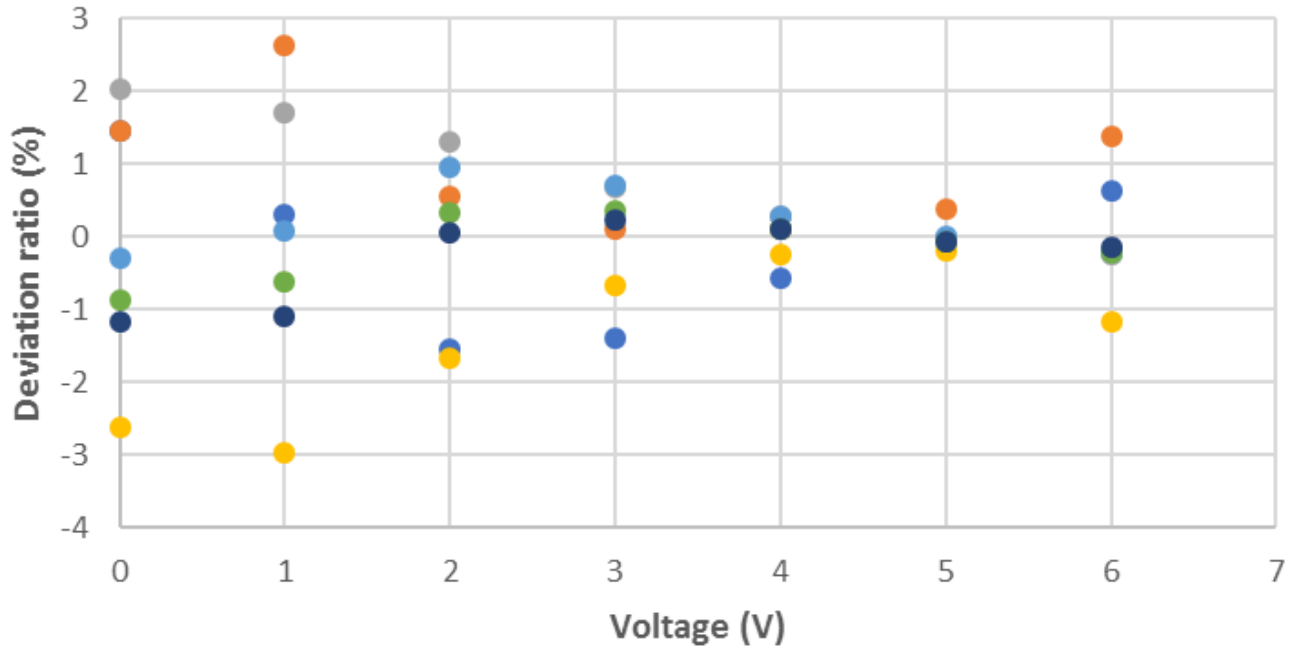

Ordering Information

Prefix	Non-Power State*	Wavelength**	Package	Type	Fiber Type***	Fiber Cover	Fiber Length	Connector
VOAM-	Transparent = T Opaque = O	1260~1620 = B 1310 = 3 1550 = 5 850 = 8 850/1310 = A 780 = 7 1060 = 1 980 = 9 Special = 0	Ø2.5mm = 2	Standard = 1 Special = 0	SMF-28 = 1 PM1550 = B PM980 = E PM850 = F MM 50/125 = 5 MM 62.5/125 = 6 Special = 0	Bare fiber = 1 0.9mm tube = 3 Special = 0	0.5m = 2 1.0m = 3 Special = 0	None = 1 FC/PC = 2 FC/APC = 3 SC/PC = 4 SC/APC = 5 LC/PC = 7 LC/APC = A LC/UPC = U Special = 0

NOTE:

* “transparent” means no attenuation without applying a controlling voltage, the “opaque” means the highest attenuation without applying a controlling voltage

** B, 3, 5 are the same device measured at different wavelengths. For B, it is typically measured at 1550nm; other wavelength measurements cost more. 8 and A are the same device measured at different wavelengths.

*** **PM1550** works for 1310-2000nm. **PM980** works for 1060nm

MEMS Fiber Optical Variable Attenuator Ø 2.5 mm 2D

(850nm, 1260-1630nm, 500mW)



DATASHEET

Typical Electrical to Optical Response

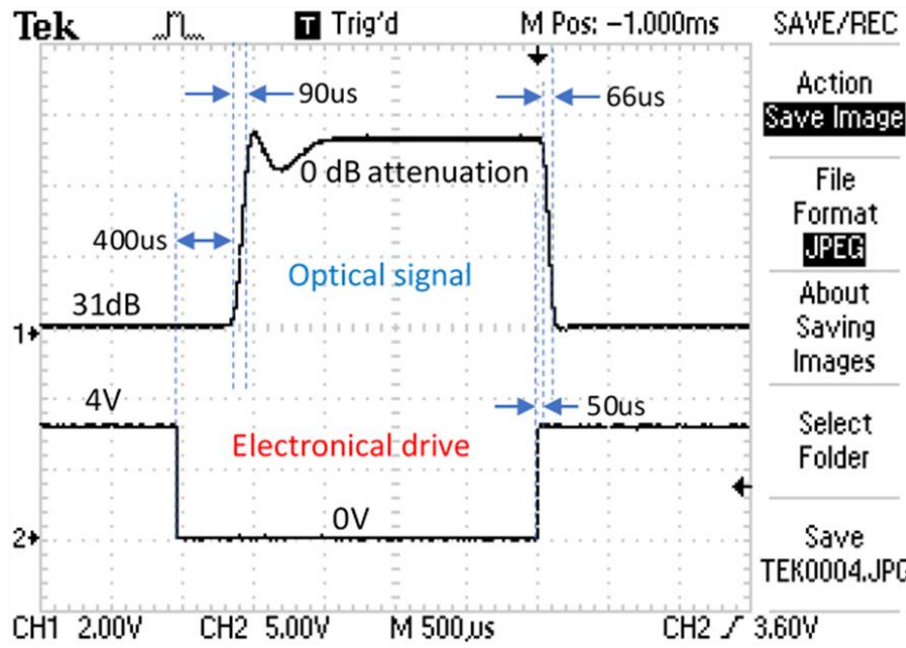

Application Notes

Fiber Core Alignment

Note that the minimum attenuation for these devices depends on excellent core-to-core alignment when the connectors are mated. This is crucial for shorter wavelengths with smaller fiber core diameters that can increase the loss of many decibels above the specification if they are not perfectly aligned. Different vendors' connectors may not mate well with each other, especially for angled APC.

Fiber Cleanliness

Fibers with smaller core diameters (<5 µm) must be kept extremely clean, contamination at fiber-fiber interfaces, combined with the high optical power density, can lead to significant optical damage. This type of damage usually requires re-polishing or replacement of the connector.

Maximum Optical Input Power

Due to their small fiber core diameters for short wavelength and high photon energies, the damage thresholds for device is substantially reduced than the common 1550nm fiber. To avoid damage to the exposed fiber end faces and internal components, the optical input power should never exceed 20 mW for wavelengths shorter 650nm. We produce a special version to increase the how handling by expanding the core side at the fiber ends.